



Integrated VGA & RS-232 Extender Option:

- Video signal transmission length up to 1,000 ft (330m) over CAT5e cable
- Adjustable equalization and gain control
- De-skew compensation available for RGB delay control
- 24VDC Input

ADM-5815AX

Waterproof 15-inch KVM Extender Integrated LCD Display Monitor

Features

- 15-inch LCD Display, 1024 x 768 resolutions
- 5-Wire Resistive Touch Screen
- Waterproof Stainless-Steel Enclosure
- Enclosure meets IP65 / NEMA 4X requirements

Integrated HDMI & USB Extender Option:

- Single CAT6 cable connection to KVM Transmitter
- True one-cable solution up to 100 meters CAT6 cable, no power supply is required
- Powered by Transmitter
- Built-in a 2-port USB 2.0 hub to support multiple USB devices.
- Built-in a 1-port 100BaseT Ethernet pass-through

Specifications

Model Name	ADM-5815AX
LCD Display	
Display Size (Diagonal)	15"
Max Resolution	1024 x 768
Backlight Lifetime (Hours)	50,000 hours
Visual Characteristics	
Colors	16.7 million
Aspect Ratio	5:4
Viewing Angle (V/H)	140° / 160°
Contrast Ratio	700:1
Brightness	300 nits
Input Interface	
VGA	Via VGA Transmitter
DVI	N/A
HDMI	Via HDMI Transmitter
Display Port	N/A
CVBS	N/A
YPbPr	N/A
Touchscreen	
Technology	5-Wire Resistive
Interface	RS-232 Via VGA Transmitter / USB Via HDMI Transmitter
Driver	Win XP, Win 7, Win10
Enclosure	
Color	Stainless Steel
Protection	Meets NEMA 4X
Power/Thermal Specs	
Power Requirement (Max)	24VDC / 0.44A
Power Consumption (Max)	11 W
Recommended Power Supply	15 W
Heat Dissipation	36 BTU/hr
Physical Information	
Mounting	Multiple Mount Options
Net Weight	27 Lbs/ 12.24 kg
Dimension (W x H x D)	14.51 x 12.42 x 4.09 inch
Recommended Cutout Dimension (WxH)	368.6 x 315.5 x 103.9 mm
Environmental	
Operating Temperature	0 to 50°C (32 to 122°F)
Storage Temperature	-20 to 60°C (-4 to 140°F)
Humidity	5% to 95% non-condensing
Rating	Meets NEMA 4X
Certification	UL508

Dimension Drawing

Model Name: ADM-5815AX
Size Unit: inch(mm)

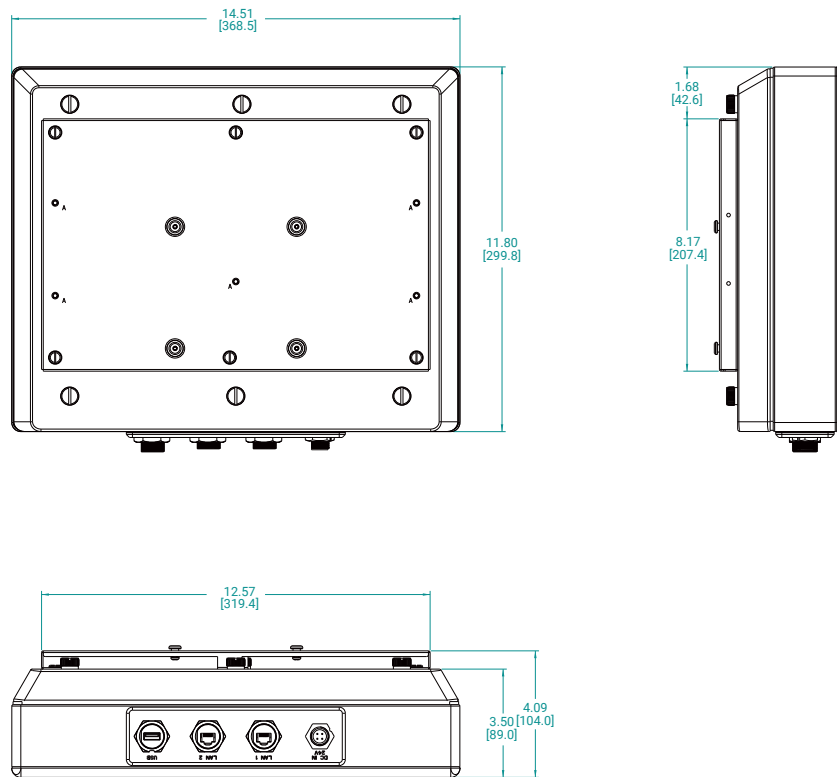

Ordering Information

Item	ADM-5815AX-00A
LCD Display	15" / 1024 x 768
Touch Screen	5-Wire Resistive
Enclosure	Stainless Steel
Extender Video Input	HDMI via HDMI Transmitter
Power Supply	Powered by HDMI Transmitter